



NOVASAIL
NS-START
POCKET^{V2}

Operating Manual

Contents

Introduction	3
Installation	4
Controls and display description	5
Screens and modes	5
Operations	6
• Switching power on and off	6
• Switching backlight on and off	8
• Run screen	8
• Start screen, timer	8
• Start screen, start line distance	9
• GPS data logger	11
• Current GPS coordinates	11
• Max speed and average speed	11
Advanced operations	12
• SET mode.....	12
• PC mode.....	16
Limited Warranty	19
Disclaimer	20

Welcome to the **NS-START POCKET V2**

The **NS-START POCKET V2** has been designed to provide essential information with a very simple and user friendly interface. Speed, heading, timer, start line distance and GPS coordinates functions are all accessible at the push of a button and clearly displayed on the backlit LCD, ideal for night sailing and enhanced safety.

The new **V2** version has an upgraded button panel and an LCD mounted on a soft silicon pad to withstand the toughest environment. It features also a Bluetooth communication transceiver offering a wide range of functions and applications:

- Record up to 1248 hours of racing (1 point / 30 seconds)
- Replay on Google Earth and other navigational software
- Updates with new features

Compact (125 mm x 80 mm x 26 mm) and intuitive, the

NS-START POCKET V2 is a light, portable device, which is completely waterproof, ultra robust, made of bombproof polycarbonate and stainless steel. It features an upgraded button panel and LCD mounted on a soft silicon pad to sustain the toughest environment.

Powered by only one AA battery, the **NS-START POCKET V2** gives sailors accurate information for over 30 hours. It can be installed in minutes and there is no need to drill a hole in the hull or use a wired connection.

We hope you enjoy sailing with the **NS-START POCKET V2**. We encourage you to read this manual thoroughly to learn about the many features of your exciting new NOVASAIL product.

Installation

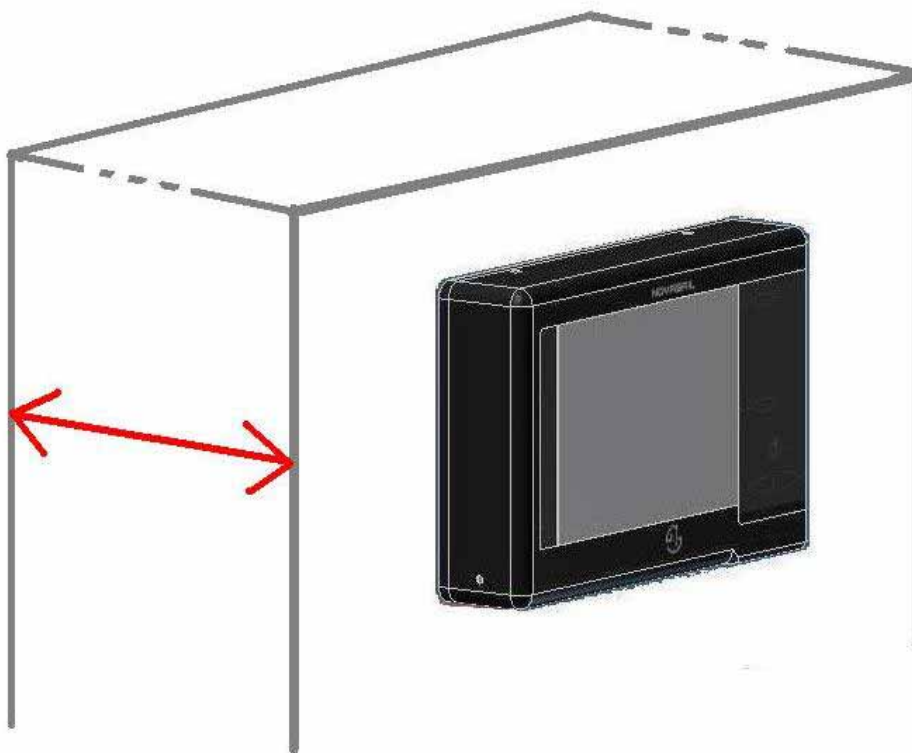

Wherever you mount the **NS-START POCKET V2**, it shouldn't be flush to any thick surface such as the hull, so that the sensitivity of the embedded GPS receiver is not affected. Also a direct mount on a metal surface will reduce the receiver sensitivity.

Controls and display description

Buttons & display

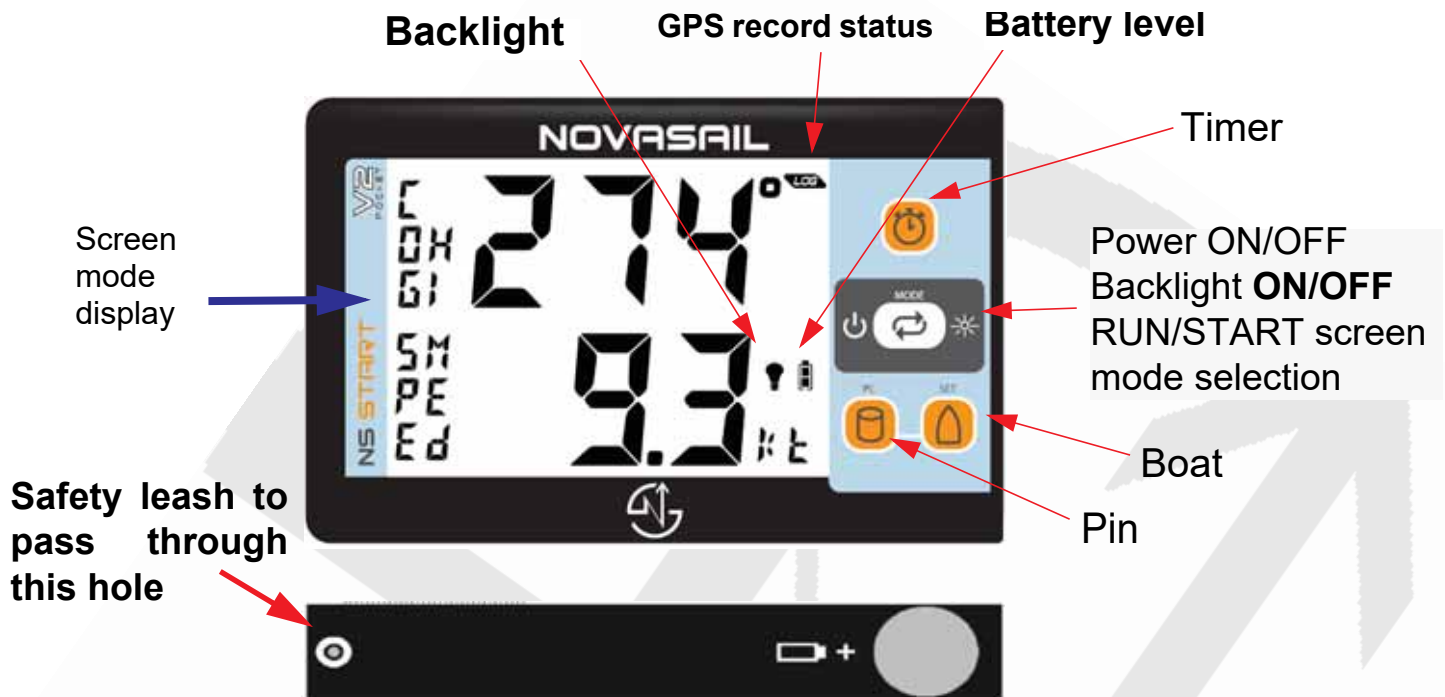

Screens and modes

The **NS-START POCKET V2** has 2 main modes of operation : the RUN screen and the START screen. Switching screens is made by pressing the button .

RUN Screen





Course Over Ground- GPS Compass: **COG**
Speed Over Ground: **SPE**

START Screen

Timer: **TIM**
Start Line Distance: **SLD**

The **NS-START POCKET V2** has 1 information screen. The GPS coordinates and the average/max instant speed recorded during the current trip

Operations

can be displayed by holding  and  simultaneously (and another press on  or  to select the desired information)

Information screen

Current GPS coordinates

Latitude
Longitude

Max instant speed recorded

SPE MAX



Average speed recorded

SPE AVG

Switching power on and off

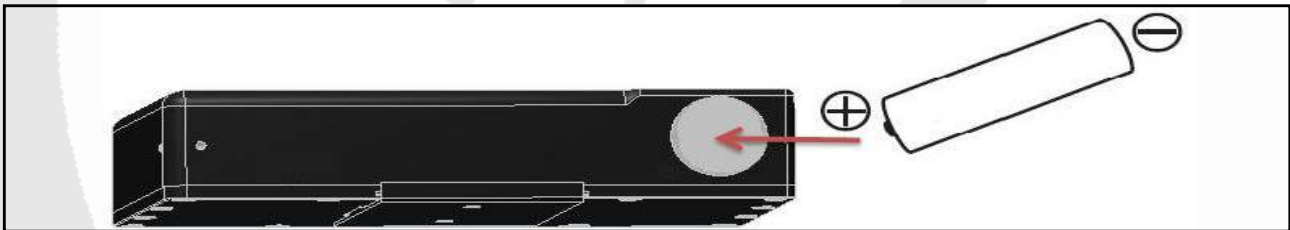
- Make sure the battery is installed with the correct polarity and has enough remaining power (positive pole inserted first)



- Press  to start the device. Press and hold  for more than 4 seconds until the screen displays OFF and the sequence “3”, “2”, “1” is finished.

The device will turn off automatically when it cannot receive any GPS signal for 20 minutes.

During the power up, the remaining time for the data logger is displayed for 5 seconds. This time, called GPS LOG, is given in hours as shown below.



Note : If the device does not turn on, you need to check that the battery is fully charged, that the battery compartment is clean, dry and the polarity is correct. **No liquid should get into the battery compartment** as it may cause internal damage. The 2 springs for the +/- battery contacts can be removed/cleaned as well as the bottom of the battery compartment with a small piece of cloth moistened with rubbing alcohol.

Note: **Rinse with fresh water, do not use corrosive products. Especially any petroleum/mineral based product will damage permanently the plastics and rubber parts (the warranty will be void). For example never use (non exhaustive list): white spirit, acetone, any spray or liquid contact cleaner, grease remover, do never spray any product into the battery compartment.**





Note : Until enough satellites are locked, the **NS-START POCKET V2** is not ready to use. For all modes requiring the GPS data, the screen will display "--" until it is ready. If the number of satellites is low, the display will blink.

Note : Disposable alkaline batteries are not recommended, but can be used to reach the maximum 40-hour battery life of the **NS-START POCKET V2**. It is **mandatory** to remove disposable batteries if the device is not going to be used for a prolonged period of time (a week or more) to avoid **battery leakage**, as this will **irreversibly damage the battery compartment**. Therefore we recommend that rechargeable batteries with a low self discharge rate should be used (normal rechargeable batteries lose their stored energy quickly even when they are not being used), and will last for 30 hours or more. Recommended batteries are

Operations

SANYO ENELOOP, GP RECYKO+, UNIROSS HYBRIO (2000mA or more typical capacity).

Switching backlight on and off

- Press and hold  for more than 1 second until the icon  is displayed on the screen. If the OFF sequence starts, simply release the button  before the sequence “3”, “2”, “1” is finished.
- To turn off the backlight, press and hold  for more than 1 second until the icon  disappears from the screen.

Run Screen

This screen provides the heading and speed of the vessel.

COG (compass), upper line : The course over ground (heading in degrees) as measured by the GPS receiver is displayed. The value displayed can be averaged, see the SET mode.

SPE (speed), lower Line : The speed over ground is displayed with a resolution of 0.1 knots (kts). The minimum speed is 0.5 knot, the maximum speed is 99.9 knots. The value displayed can be averaged, see the SET mode.
Start Screen

Start Screen

TIMER, Upper Line : This mode offers a 5 minutes countdown timer, which can be synchronized to 5, 4 and 1 minutes.

At the start time:

- the timer starts counting the race duration in minutes and hours

To synchronize the TIMER when it is stopped:

- Long press 🕒 to synchronize to 5, 4 or 1 minutes (starting time).

To start the TIMER:

- Short press 🕒 to start the timer from the value previously set.

To synchronize the TIMER when it is running:

- Short press 🕒 to synchronize to 5, 4 or 1 minutes. If the timer value is greater than 2:45, the timer will synchronize to 4 minutes. If lower than 2:45, it will synchronize to 1 minute. The timer continues counting down.

To stop the TIMER:

- Press and hold 🕒.

Note : With the GPS logger synchronized to the upcounting of the timer, the GPS logger stops when the timer is stopped or restarted in order to log the end of the current sail.

Note : When the down counter reaches '0:00', the timer and the start line distance will switch automatically to the 'RUN' screen (compass and speed).

Start Line Distance (SLD), lower line : knowing the exact distance in meters to the start line gives a huge advantage in helping you start ahead of the fleet and win the race. The boat offset parameter allows you to set the distance from the bow to the line.

The resolution of the distance to the line is 1 meter. The maximum distance is 999 meters.



Operations

The start line consists of 2 points which have to be aligned with the start line:

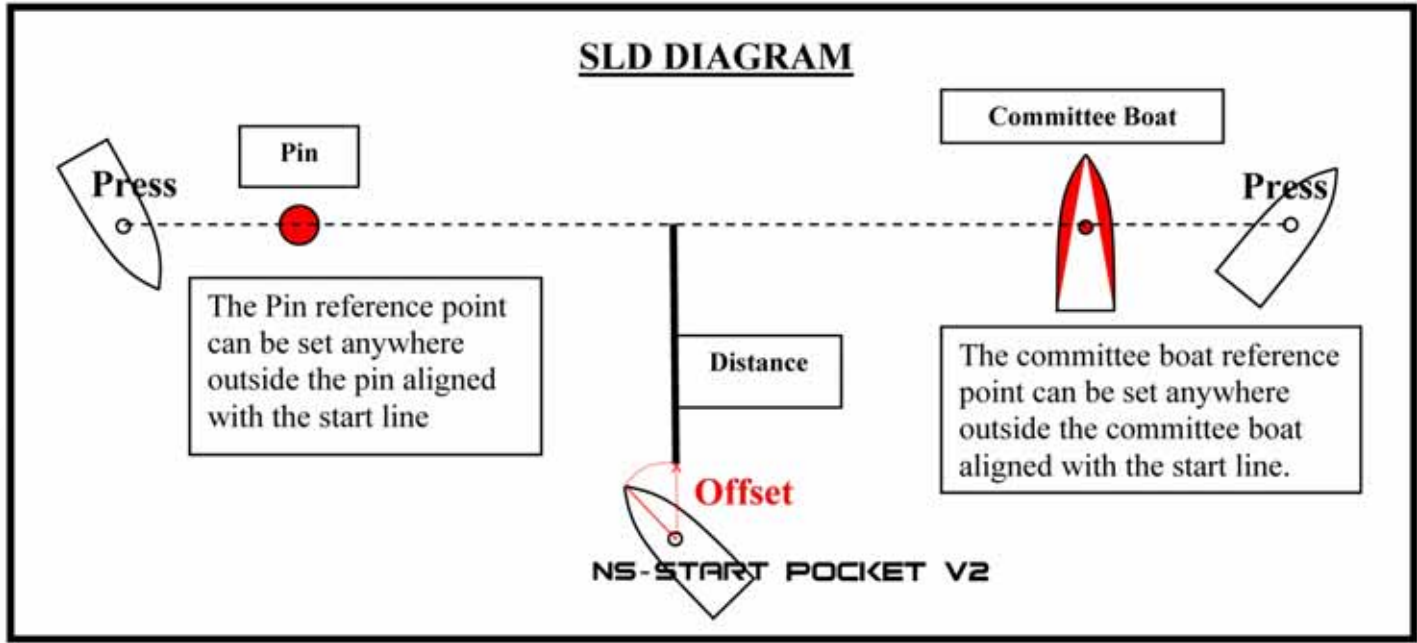
-  : Committee boat
-  : Pin





To memorize the start line points

- Press  when you reach the committee boat reference point.
- Press  when you reach the pin reference point.
- The distance in meters is now displayed on the data line.

Note : *If the start line is modified by the committee, you may be required to re-enter one or both reference points.*

Note : *The distance from the front of the boat to the*

NS-START POCKET V2 *can be defined in the SET mode.*

Note : *If the pin and the boat references are recorded with  and  (instead of  and ) the **NS-START POCKET V2** will show a sign '-' instead of a '+' for the distance to the line (only the sign is changed, the overall distance calculation is not impacted)*





GPS Data Logger

A GPS data logger is embedded in the **NS-START POCKET^{v2}** allowing you to download all your sailing data to your computer using the **NS-START POCKET^{v2}** Wireless Manager software.





Upon setting the GPS data logger start parameter, the logger will start recording as soon as enough satellites are locked or when the timer reaches 0:00'.

The recording interval can also be set using the parameter GPS Logger Timing (see the SET mode, page 15 for details).

Current GPS coordinates

This mode allows the latitude and longitude of the current position to display (in degrees and decimal minutes). To activate this mode, you need to press the arrows  and  simultaneously (if needed select this screen by another press on  or ). The latitude is displayed on the upper line and the longitude on the lower line. Press  on to exit this mode.

Max speed and average speed

This mode allows the display of the max instant speed on the upper line and the max average speed on the lower line. To enter this mode, you need to press the arrows  and  simultaneously (if needed select this screen by another press on  or ). The average speed (lower line, 'AVG x', x=3 to 10) is computed on a 3 to 10 seconds time interval, based on the parameter entered in the setup menu (see the SET mode, page 15 for details). Press  on to exit this mode.





Advanced operations

SET mode

The **SET** mode allows the adjustment of your **NS-START POCKET v2** parameters sequentially as follows :

- Speed sensitivity
- GPS heading sensitivity
- Boat offset
- GPS logger interval
- GPS logger start condition
- Time in seconds for the average maximum speed calculation
- Current embedded firmware version

To enter the SET mode :

- Your device must be switched OFF.
- Press first  then  simultaneously. The device will enter the setup menu: **SET** will be displayed on the upper line
- Each parameter is displayed on the lower line. The required value is adjusted by the button .
- The parameter is memorized when you press and hold the button .
- The **SET** mode is exited by switching off the device (the current setting is memorized when switching off).

Name	Display	Description
Speed sensitivity	SPE	<ul style="list-style-type: none">• Hi: High sensitivity• Med: Medium sensitivity• Lo: Low sensitivity
GPS heading sensitivity	COG	<ul style="list-style-type: none">• Hi: High sensitivity• Med: Medium sensitivity• Lo: Low sensitivity

Advanced operations

Boat offset	BOA OFS	This is the length between the front of the boat and the NS-START POCKET^{v2} Default value 0, can be adjusted in 0.1 meter increments.
GPS logger Interval	LOG TIM	Timing interval between 2 data (GPS coordinates). Default is 3 seconds, can be adjusted in 1 second increments up to 30 seconds.
GPS logger start	LOG STA	<ul style="list-style-type: none">• On (starts as soon as enough satellites are locked)• Off• Tim (starts when timer reaches 0:00)
Average time for the max speed	SPE AVG	3 to 10 seconds for the average maximum speed computation
Firmware version	VER	Firmware version number

Note: You can exit the SET mode any time by restarting the device.

Speed Over Ground sensitivity : SPE

- **Hi: High sensitivity**

The high sensitivity setting allows a very sensitive reading of any speed variation.

- **Med: Medium sensitivity**

This sub-mode provides an average speed of the boat over a short period of time. This is particularly useful when sailing with big waves upwind or downwind.

- **Low: Low sensitivity**

This sub-mode provides an average speed of the boat over a longer period of time. This is particularly useful in rough conditions with lots of speed changes.

Advanced operations

GPS Heading sensitivity : COG

- **Hi: High sensitivity**

When sailing with light winds and flat seas, high sensitivity allows you to appreciate very small wind variations.

- **Med: Medium sensitivity**

Medium sensitivity is more suitable for race boats under medium wind and sea conditions. Dinghy racers will appreciate this mode.

- **Low: Low sensitivity**

Under low sensitivity more subtle variations due to big waves and sudden gusts are filtered.

Boat offset: BOA OFS

The boat offset corresponds to the distance from the front of the boat to the **NS-START POCKET**^{v2}. The remaining distance to the start line is calculated by taking the boat offset into account. The default value is 0, the maximum value is 20.0 meters and the increment is 0.1 meter.

Example: The actual distance between the front of the boat to the **NS-START POCKET**^{v2} is 3.2 meters. You need to enter a boat offset of 3.2 meters. Then, considering that the **NS-START POCKET**^{v2} is 10 meters from the line, when you face the start line, the displayed remaining distance is equal to 10-3.2 meters, 6.8 meters rounded down to 6 meters.

GPS Logger interval: LOG TIM

The GPS Logger recording interval can be set between 1 to 30 seconds with a default value of 3 seconds. For example if set to 3, then every 3 seconds GPS data is recorded. Once downloaded on your computer, the lower the value of the interval the more accurate the trace and the post race analysis will be.

GPS Logger Start: LOG STA

The GPS Logger can be set to:

- **OFF:** GPS Logger is turned off
- **ON:** The GPS Logger records the data when the **NS-START POCKET^{v2}** is ON and as soon as enough satellites are locked
- **TIM:** The GPS Logger starts to record the data when the timer reaches 0 and continues until the timer is reset

Average time for the max speed: SPD AVG

The max speed displayed in the dedicated mode (see “Max speed and average speed”, page 11) is averaged based on the time entered, from 3 to 10 seconds.

Firmware version: VER

The firmware version is displayed (for example: 1.2).



Advanced operations

PC Mode

The **PC** mode is activated to exchange data between the

NS-START POCKET V2 Bluetooth wireless transceiver and the computer. The "NS-START Pocket V2 Wireless Manager" software allows you to check the communication status, upgrade the embedded firmware & setup the device. Please refer to the Novasail Wireless Manager documentation for more details; the online manual can be open with a right click on the "NS-START Pocket V2 Wireless Manager" main window.

To enter in PC connectivity mode

- With the product switched off, press first  then  simultaneously. "PC" is displayed on the data line of the upper screen (blinking) (blinking) with "blu" (bluetooth) shown
- To exit the PC mode, press and hold the button .

Troubleshooting

- Make sure the Bluetooth connectivity is activated on the PC
- Make sure to allow any Bluetooth device to find the PC in the operating system
- Close/re-open the "NS-START Pocket V2 Wireless Manager" app. Remove the **NS-START POCKET V2** from the previously paired bluetooth devices and launch a new pairing process
- Make sure the PC mode on the **NS-START POCKET V2** is turned on: "PC" **must** be blinking on the main display and "blu" (Bluetooth) must be shown on the lower line
- Confirm the **NS-START POCKET V2** is indicated on the available Bluetooth devices on the PC
- The message 'connected' should appear in green at the bottom of the "NS-START Pocket V2 Wireless Manager" window within a minute (the delay is PC hardware dependant)

Note: *to save batteries the **NS-START POCKET V2** will shut down automatically if no PC connectivity is detected for 10 minutes.*

Advanced operations

Screen capture example, Windows 10 Bluetooth settings. Once the **NS-START POCKET V2** is paired AND in an active connection (otherwise it will show as paired only) the device appears as followed:

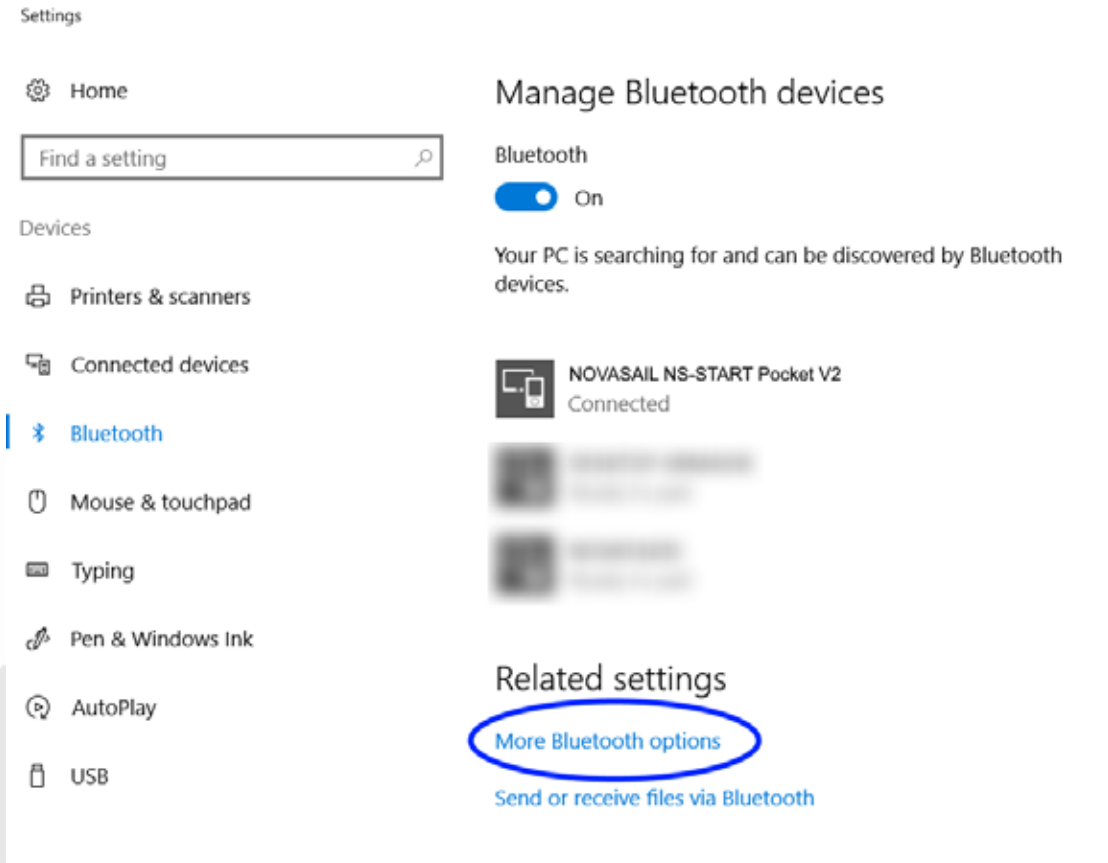

In the Bluetooth options (Windows 10 screen capture), additional information should be displayed as followed (the COM port numbers may be different):

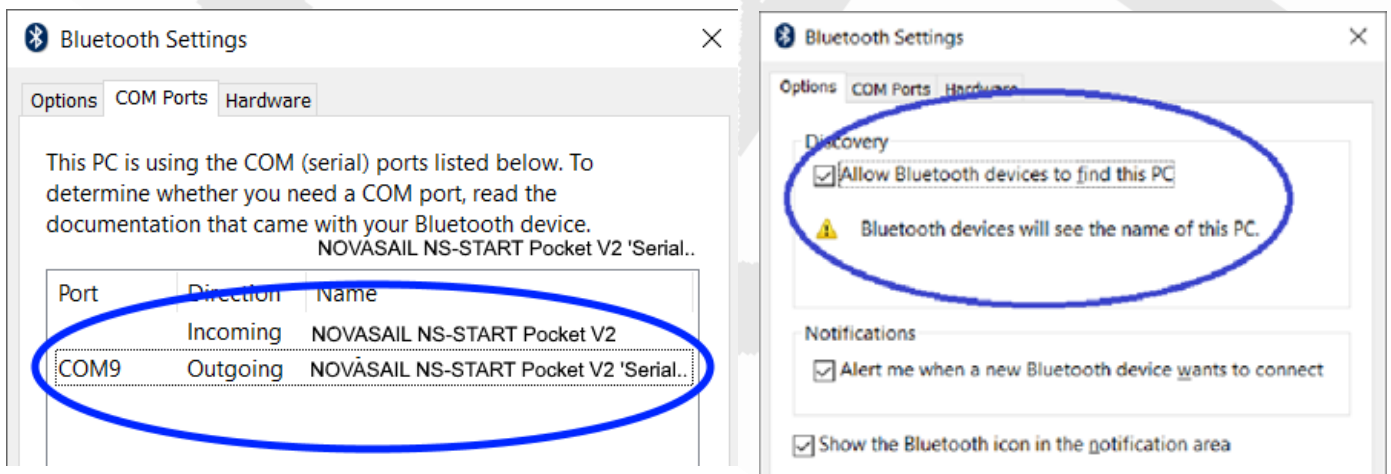

Document history

Version 1.0: First version

Version 1.1: Modified 'Switching power ON/OFF' chapter: corrosive products

Please visit www.nova-sail.com for the latest user manuals and updates.

Limited warranty

This product meets or exceeds all of Novasail's8 rigorous quality controls and inspection standards. Complete services will be provided in accordance with the statement of warranty set forth below if any manufacturing defect or natural failure occurs within the warranty period.

Warranty Terms and Conditions

- If any defect arises under normal conditions of use within the warranty period, our customer service center or specified partner will provide the required repair services at no charge, or legally applicable services according to the appropriate consumer protection laws and regulations of the country in which the product was purchased by the warranty holder.
- The product has to be registered using the online service available on the Novasail web site: www.nova-sail.com
- Please submit the proof of purchase (Invoice) when requesting service.
- The actual cost of repair may be charged to the customer or the performance of warranty service may be rendered impossible, even within the warranty period, under the following circumstances:
 - Product failure caused by accident or carelessness
 - Disassembly or modification for purposes other than it was originally intended for
 - Failure caused by a fire, earthquake or flood
 - Damage/failure caused by an impact
 - Failure caused by inappropriate services performed by anyone other than Novasail's customer service center or one of Novasail's service specified partners
- For assistance in obtaining service, please contact Novasail service center:

E-mail: contact@nova-sail.com
www.nova-sail.com

Information in this document is provided solely in connection with NOVASAIL LTD products. NOVASAIL LTD reserves the right to make changes, corrections, modifications or improvements to this document and the products described herein at any time, without notice.

All NOVASAIL LTD products are sold pursuant to NOVASAIL LTD's terms and conditions of sale.

Purchasers are solely responsible for the choice, selection and use of the NOVASAIL LTD products described herein, and NOVASAIL LTD assumes no liability whatsoever relating to the choice, selection or use of the NOVASAIL LTD products described herein.

UNLESS OTHERWISE SET FORTH IN NOVASAIL LTD'S TERMS AND CONDITIONS OF SALE, NOVASAIL LTD DISCLAIMS ANY EXPRESS OR IMPLIED WARRANTY WITH RESPECT TO THE USE AND/OR SALE OF NOVASAIL LTD PRODUCTS, INCLUDING WITHOUT LIMITATION IMPLIED WARRANTIES OF MERCHANTABILITY OR FITNESS FOR A PARTICULAR PURPOSE (AND THEIR EQUIVALENTS UNDER THE LAWS OF ANY JURISDICTION).

UNLESS EXPRESSLY APPROVED IN WRITING BY AN AUTHORIZED NOVASAIL LTD REPRESENTATIVE, NOVASAIL LTD PRODUCTS ARE NOT RECOMMENDED, AUTHORIZED OR WARRANTED FOR USE IN MILITARY, AIR CRAFT, SPACE, LIFE SAVING, OR LIFE SUSTAINING APPLICATIONS, NOR IN PRODUCTS OR SYSTEMS WHERE FAILURE OR MALFUNCTION MAY RESULT IN PERSONAL INJURY, DEATH, OR SEVERE PROPERTY OR ENVIRONMENTAL DAMAGE.

Resale of NOVASAIL LTD products with provisions different from the statements and/or technical features set forth in this document shall immediately void any warranty granted by NOVASAIL LTD for the NOVASAIL LTD product or service described herein and shall not create or extend in any manner whatsoever, any liability of NOVASAIL LTD.





© 2017 NOVASAIL - All rights reserved
www.nova-sail.com